



ZERO
Generation 2

Mazda Donor



ZERO
Generation 2

Single Donor Kit



www.greatbritishsportscars.com



You can select from a variety of packages to suit all budgets from our starter kit through to a complete kit of components that can be assembled easily by yourself.

The GBS Zero range is available as right hand or left hand drive and as a Standard width or GT (grand tourer /wide body) chassis option, which allows greater access and a more comfortable seating position for the taller/larger driver.

Whatever the journey you're guaranteed your GBS Zero will turn heads, gather smiles and create new friends.

GBS Zero Mazda:

The Mazda MX5 / Miata serves perfectly as a single donor, and is readily available worldwide with of over 900,000 cars produced.

The kit utilises MX5's / Miata's (Mk1, Mk2, Mk2.5) years 1989 through to 2005 in either RHD or LHD.

Custom engine kits are available upon request.

Parts required from the donor (Mazda MX5 / Miata option)

- Engine 1.6 or 1.8
- Gearbox
- Differential
- Front Hubs & Calipers*
- Rear Hubs & Calipers*
- Steering Shaft*
- Steering Column with Stalks*
- Brake Master Cylinder
- Clutch Master Cylinder
- Propshaft*
- Drive Shafts

Whats new:

With over 10 years of Zero production experience we have now developed the Second Generation car compiling a decade of refinements into one simple to order package.

'The second generation Zero is far from a typical kit car, there are vast improvements that takes away the challenges normally associated with self builds whilst still providing a rewarding build experience'.

Numerous refinements have been incorporated as standard to not only improve the building experience of a Zero but also to ensure a high quality and safe vehicle when built. The Zero has an unprecedented handling due to its 50/50 weight distribution achieved by moving the engine rearward from the front axle, this is complimented by fully independent front and rear suspension arms.'

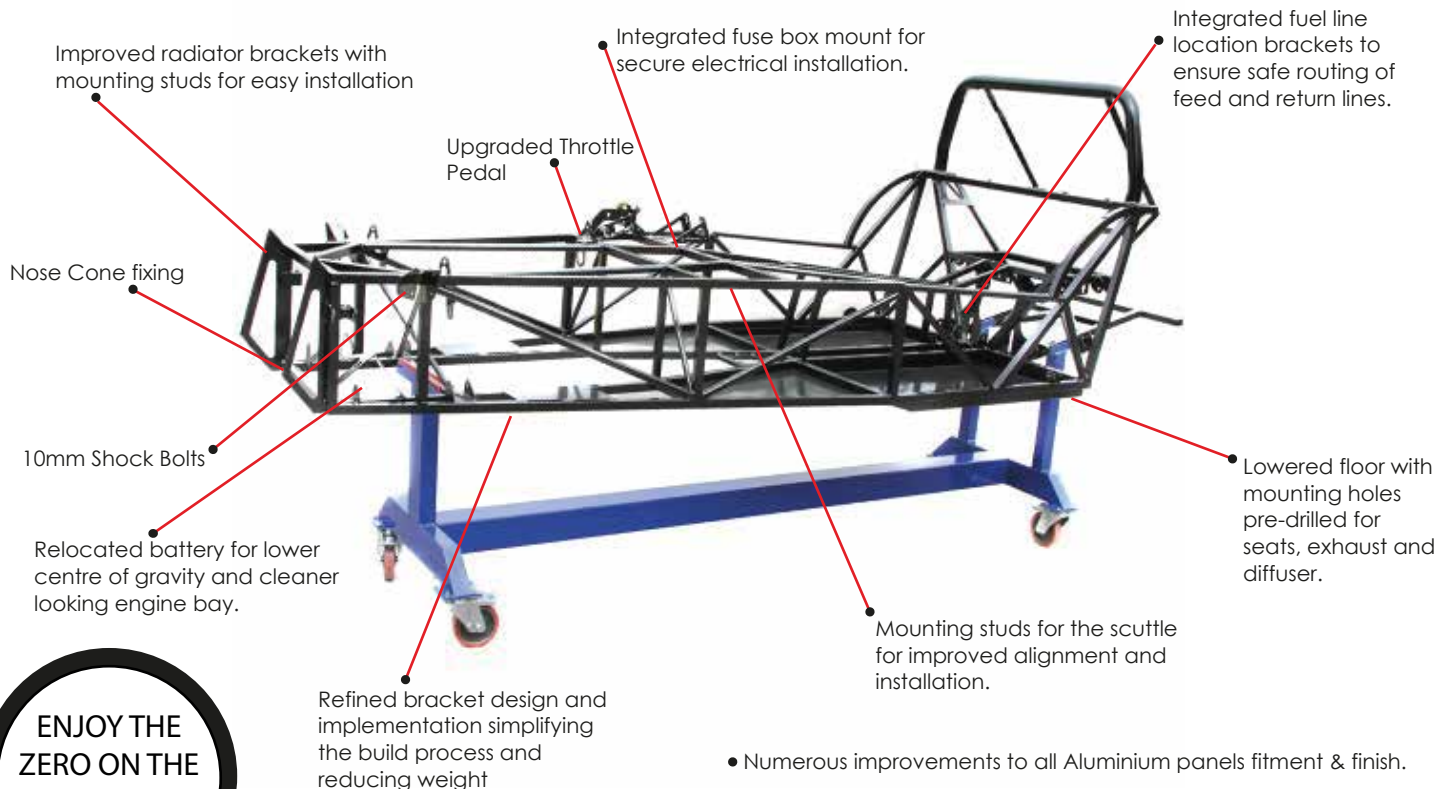

ENJOY THE
ZERO ON THE
ROAD &
TRACK.

Included as standard in the Zero Mazda Kits....

£3,797.00 inc VAT

ZERO

Starter Self Build kit

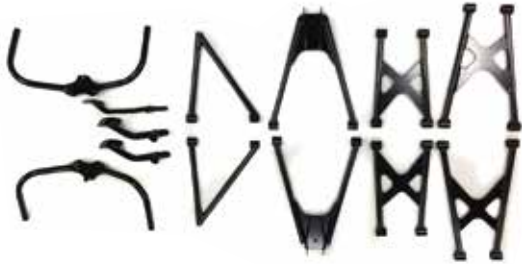

■ **Second Generation Zero Base Kit includes:**

- **Generation 2 CHASSIS** - Powder Coated & with a lowered floor as standard
- **WISHBONES & PEDALS** - Powder Coated
- **PANELS** - Aluminium pre folded Generation 2 All interior & exterior panels
- **GRP (Choice of 9 Colours)**
5 piece GRP Set - Nose Cone, Front Sports Wings and Rear Wings.

Upgrade Package

ZERO PLUS KIT

£4,997.00 inc VAT

■ **Second Generation Zero Plus Kit includes:**

- **Second Generation Zero Base Kit above**
- **Easy Fit Electrical Harness**
- **Zero Shock Absorber Set**
- **Zero Radiator**
- **Lighting Pack**
- **GRP Dash (Choice of 9 colours)**
- **Bolt kit & Shock Bolts**



Enjoy the Zero on the Road & Track

Visit our website to download a more detailed list of kit contents.

*Panel car chassis for illustration purpose only, all panels are supplied pre folded / flat. Build Trolley is not included in kit price.







ZERO MAZDA SELF BUILD OPTIONAL EXTRA'S

• Self Build Zero Generation2 Kit	KOE0133	£3,797.00	<input type="checkbox"/>
• Self Build Zero Generation2 PLUS Kit	KOE0134	£4,997.00	<input type="checkbox"/>
• LHD (European & International)	KOE0101	£200.00	<input type="checkbox"/>
• Zero GT (Wide Body)	KOE0102	£550.00	<input type="checkbox"/>
• Roll Cage / 5 Point Harness Mounts	CHA0068	£588.00	<input type="checkbox"/>
• Louvered Bonnet (Standard Zero only)	KOE0130	£72.00	<input type="checkbox"/>
• Painted in one colour (Fully panelled cars only)	LAB0012	From £1,440.00	<input type="checkbox"/>
• Factory Fittings & part built option available - Contact for details			





ZERO COLOUR OPTIONS

The Zero range is available in a choice of 9 GRP Colours

Standard Colours:

-  -Panther Black
-  -White
-  -Oxford Blue
-  -British Racing Green

Premier Colours additional £45.00.

-  -Gulf Blue
-  -Kawasaki Green
-  -Yellow
-  -Post Office Red
-  -Orange



Smiths Gauge Set (mph/km/h)
From £486.00



Classic Front Wings
(Option price £35.00)



GRP Bucket Seat
(£294.00 each)



Rear GRP Diffuser
(Standard £185.00/GT £205.00)



Emerald ECU - Mazda
(ELC0155 - £714.00)



Hand Brake Assembly Kit
(Mazda kit BRA0111 - £94.00)



GBS TRS Seat Belts
(Colour options - £109.99 pair)



Side Doors
(Standard & GT £372.00)



ATR Shock Absorbers
(Upgrade option price £ 652.80)



Fuel Tank With Pump & Filter Mounts
(Standard & GT £204.00)



GRP Flyscreen
(One size £75.00)



GBS Build Tressels
(Standard- £96.00/ Mini £86.00)



GBS Build Trolley
(Fitted with braked caster wheels £594.00)



High Performance ATR Alloy Radiator
(Upgrade option price £173.53)



Zero Full Carpet Set
(Standard & GT £192.00)



Exhaust Silencer
(£295.00 / £424.99 with cat)



DRL Style LED Head lights
(£78.00 pair)



ATR 45mm DCOE Throttle Bodies - MX5 Mazda 1.6 / 1.8
(Outright price £1,074.00)

Wherever you look on the Zero you can make it your own.

The additional parts required to complete your Zero can be purchased through our parts division www.kitspares.co.uk

Great British Sports Cars Ltd

@gbs_cars @GBSCars @GBSCars

