



ZERO
Generation 2

Miata Rolling Self Build



ZERO

Generation 2

USA Miata Rolling Chassis Self Build



www.greatbritishsportscars.com

Head Quarters: Great British Sports Cars Ltd, Maun Way, Boughton, Ollerton, Nottinghamshire, NG22 9ZD, UK.

E: info@greatbritishsportscars.com T: +44 (0) 1623 860990

[@gbs_cars](#) [@GBSCars](#) [@GBSCars](#)



ZERO
Generation 2

Single Donor

USA Miata Rolling Self Build

Now available is a Zero self build kit specifically for the North American Market which is based on the abundant Mazda MX5 / Miata MK1-2.5 as a donor. The Mazda MX5 / Miata is a perfect donor for the Zero with over 900,000 MX5 / Miata cars sold worldwide.

The kit utilises MX5's (Mk1, Mk2, Mk2.5) from 1989 through to 2005 in either RHD or LHD.

Other donor and engine combinations are available upon request.

GBS Zero Mazda:

The GBS Zero range is available as right hand or left hand drive and as a Sport width or GT (grand tourer /wide body) chassis option, which allows greater access and a more comfortable seating position for the taller/larger driver.

Whatever the journey you're guaranteed your GBS Zero will turn heads, gather smiles and create new friends.

About GBS:

Great British Sports Cars is a leading name in the British and worldwide sports cars industry. With over 25 years of experience you can trust GBS to help make your classic Lotus style car a reality. Leveraging this experience, the GBS Zero has evolved using all the best elements of the past while combining them with the most up-to-date design and manufacturing processes. Since its launch in 2007 the Zero is now enjoyed by hundreds of owners around the world. GBS owners benefit from our continued development of the Zero offering an ever increasing number of products and services to enhance the cars appearance and performance.

The complete GBS in-house manufacturing and design facility enables our customers to benefit from a managed supply chain that ensure our products are delivered consistently to the high-quality standard our customers expect.

The 2000sq ft of component storage provides our customers with access to a comprehensive parts inventory to support your initial build requirements and the rapid dispatch of spares should the need arise.

Components and spares can be purchased directly from our showroom store at the factory or online at www.kitspares.co.uk.

Any member of the GBS team either located at the factory or a member of our worldwide dealer network stands ready to help and advise you.

You can trust that the range of cars and options available to you will provide superior value in terms of appearance, quality, design, performance, support and most of all enjoyment.

Parts required from the donor
(Mazda MX5 / Miata option)

- Engine 1.6 or 1.8
- Gearbox
- Differential
- Front Hubs & Calipers*
- Rear Hubs & Calipers*
- Steering Shaft*
- Steering Column with Stalks*
- Brake Master Cylinder
- Clutch Master Cylinder
- Propshaft*
- Drive Shafts

ENJOY THE
ZERO ON
THE ROAD &
TRACK.

BRITISH ENGINEERING EVOLVING

LHD Zero Sport Miata Rolling Chassis self build package

£10,328.47

ZERO

Starter Self Build kit

True Rolling Chassis

- All Bodywork
- GRP (Colour option)
- Complete Suspension
- All External Lighting
- Full Steering Package
- Wheels
- Fuel Tank
- Chassis Harness



Supplied in component form....

Please note: Panels Supplied pre folded / flat. Build Trolley not included.

Whats new:

With over 10 years of Zero production experience we have now developed the Second Generation car compiling a decade of refinements into one simple to order package.

'The second generation Zero is far from a typical kit car, there are vast improvements that takes away the challenges normally associated with self builds whilst still providing a rewarding build experience'.

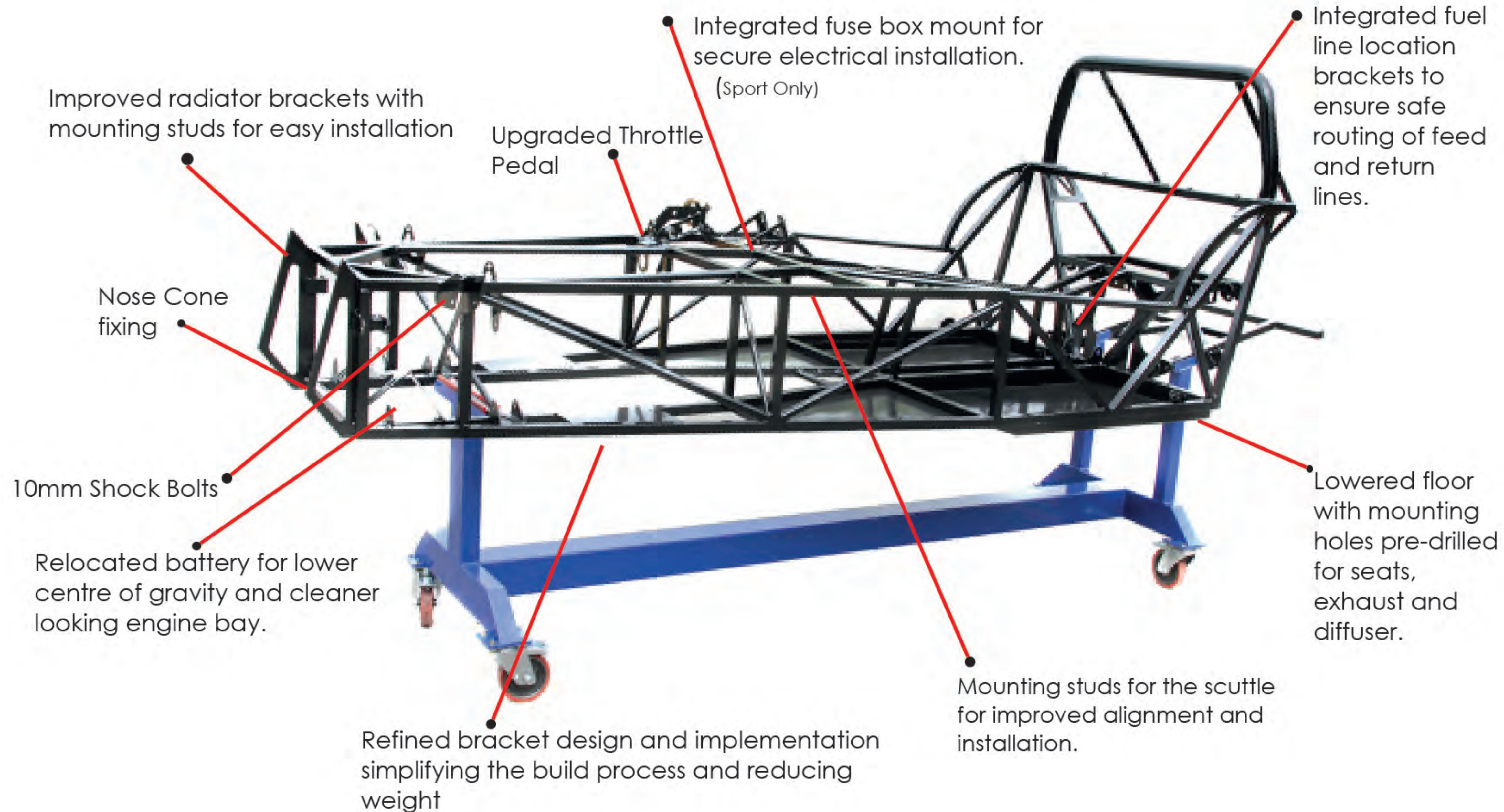

Numerous refinements have been incorporated as standard to not only improve the building experience of a Zero but also to ensure a high quality and safe vehicle when built. The Zero has an unprecedented handling due to its 50/50 weight distribution achieved by moving the engine rearward from the front axle, this is complimented by fully independent front and rear suspension arms.'

GBS Zero Miata Rolling Chassis Completion Packages:

Interior Package: PAC0008



Gear / Hand Brake Gaiter
 Colour Stitching? _____
 Black stitching is standard if not selected



Seat Belt Colour: _____
 Black seat belts are standard if not selected

GBS Custom Seats
 Colour Stitching? _____
 Black stitching is standard if not selected

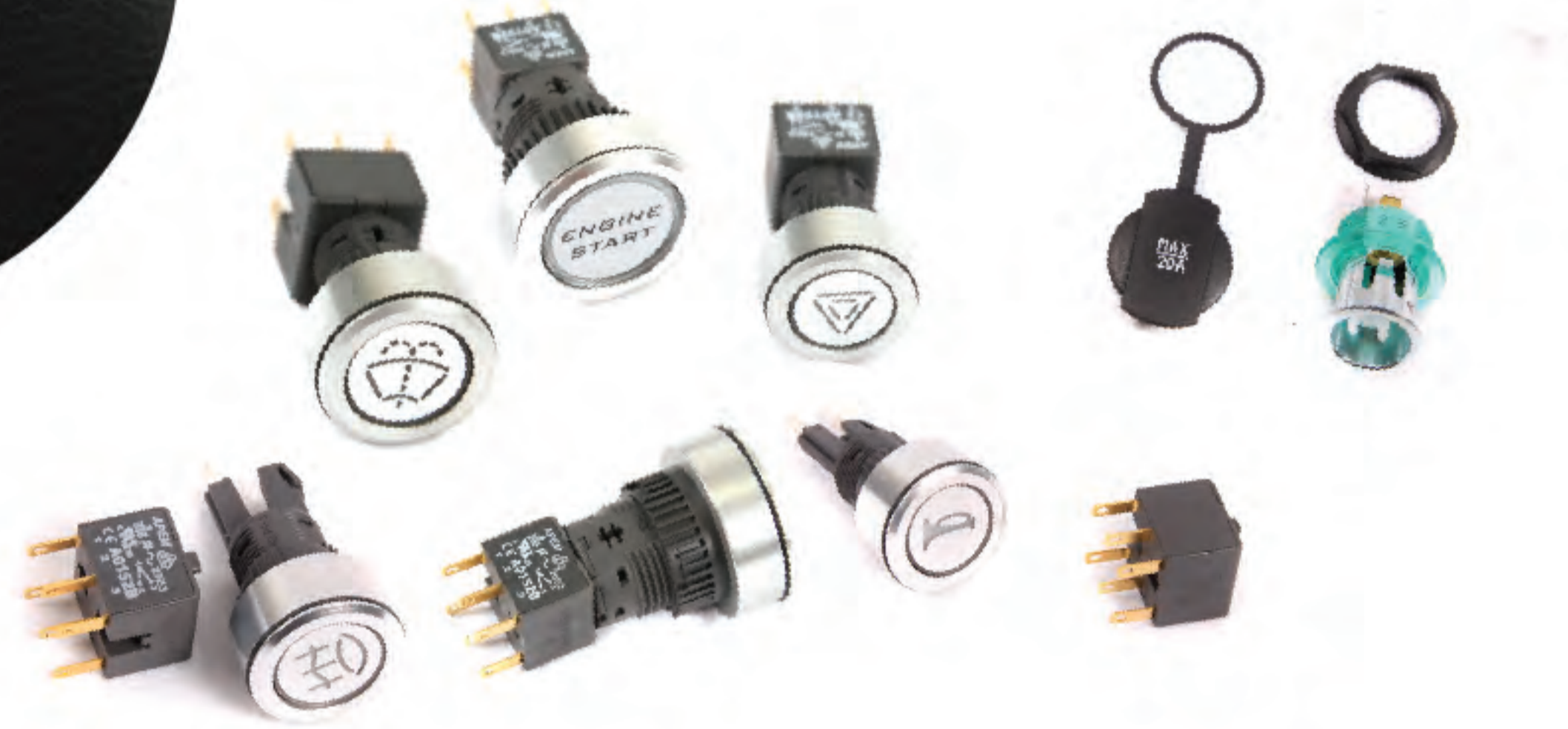

Black GRP Seats



INTERIOR PACKAGE £1,539.79

Fuel Package: PAC0009



Fuel hardware included

FUEL PACKAGE £336.40

Engine Package: PAC0010



ENGINE PACKAGE £1,565.55

Exhaust Package: PAC0011



Exhaust hardware included

EXHAUST PACKAGE £472.67

Windscreen Package: PAC0013

Windscreen is ready built with powder coated brackets



Hardware included

WINDSCREEN PACKAGE £542.17

Cooling Package: PAC0012



Cooling hardware included

COOLING PACKAGE £328.93

Please note that kit packages are for illustration purposes and are subject to change.

Instrument Package: PAC0013



Please select option:

- Chrome Bessel / Black Face
- Black Bessel / Black Face
- Chrome Bessel / White Face
- Black Bessel / White Face
- MPH
- Km/h

Warning lights in rev counter

INSTRUMENT PACKAGE £598.43

PAINT OPTION

Prepare for paint includes paneled car and fitting of GRP Nose Cone / Bodywork before paint.

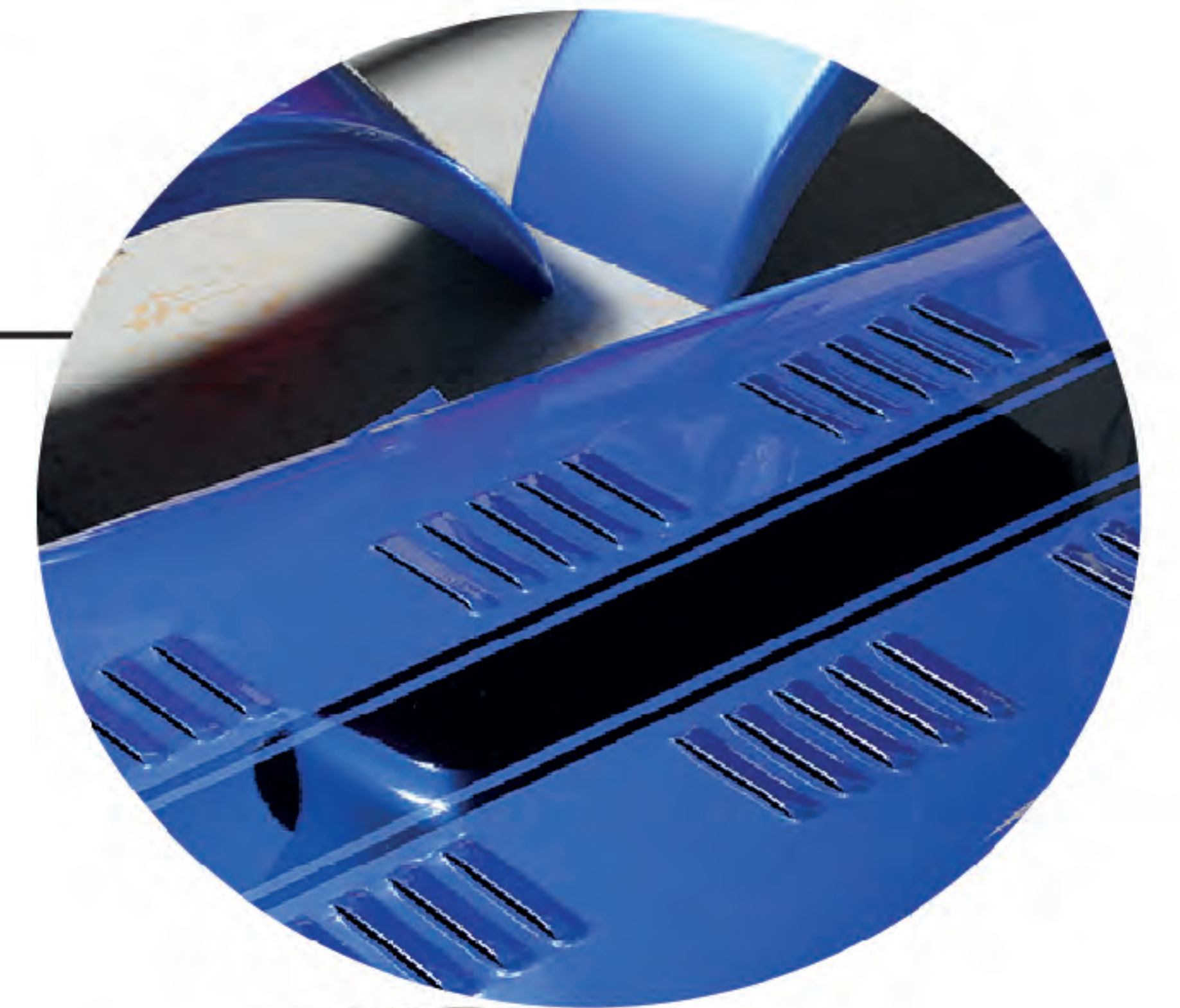

SHIPPING

Once your order is complete, it will then be packed into a custom made wooden crate ready for shipment. Shipping can be to port or address - Costs vary by destination.



Wherever
you look on
the Zero you
can make it
your own.

BRITISH ENGINEERING EVOLVING





ZERO USA MIATA ROLLING SELF BUILD ORDER OPTIONS & EXTRA'S

ZERO COLOUR OPTIONS

• LHD Zero Sport Miata Rolling Chassis self build package	KOE0049	£10,328.47	<input type="checkbox"/>
• LHD Zero GT Miata Rolling Chassis self build package	KOE0050	£10,828.47	<input type="checkbox"/>
• LHD Zero trackday roll over cage and front braces	KOE0051	£457.00	<input type="checkbox"/>
• Paint - See Paint Specification Sheet for prices & options.	-	-	<input type="checkbox"/>
PACKAGES			
• Interior	PAC0008	£1,539.79	<input type="checkbox"/>
• Fuel	PAC0009	£336.40	<input type="checkbox"/>
• Engine	PAC0010	£1,565.55	<input type="checkbox"/>
• Exhaust	PAC0011	£472.67	<input type="checkbox"/>
• Cooling	PAC0012	£328.93	<input type="checkbox"/>
• Instrument	PAC0013	£598.43	<input type="checkbox"/>
• Windshield	PAC0014	£542.17	<input type="checkbox"/>

The Zero range is available in a choice of 9 GRP Colours:

Standard Colours:

-  -Panther Black
-  -White
-  -Oxford Blue
-  -British Racing Green

Premier Colours additional £45.00.

-  -Gulf Blue
-  -Kawasaki Green
-  -Yellow
-  -Post Office Red
-  -Orange

Some other optional extras and upgrades that you might like to consider for your build:



ATR 45mm Mazda DCOE Throttle Bodies
£895.00 / ENG0235



ATR Shock Absorbers Upgrade option
£497.00 / KOE0145



Front Brake upgrade
£832.00 / PAC0015



Front Suspension & Brake upgrade
£2,200.00 / PAC0004



Rear suspension Bush Upgrade
£379.17 / PAC0007



AIM Instrument Upgrade from Smiths
£510.25 / KOE0143



DRL Style LED Head lights Upgrade option
£65.00 / LIG0009



Upgrade Cycle Wing
£29.17 / KOE0112



GRP Aero Screen
£62.50 / KOE0141



Diffuser & Bracket in Black
£174.83 / KOE0142



Carbon Fibre
Front wings / £400.00 / KOE0148
Dash / £250.00 / KOE0149
Stone Guards £300.00 / KOE0150



Carbon step over covers
£250.00 (pair) / KOE0147



Fuel pump to Motorsport Bosch
£50.00 / KOE0146



Track Day Roll Over Cage & Front Braces
See options above



Weather Gear
(Hood, doors, frame, hinges etc Side Doors / Boot Cover (Price TBC)



Battery cut off switch
£12.64 / ELC0026



'Push 'to start Button
£22.50 / ELC0085



2" Harness c/w quick release
£167.00 / KOE0144



GBS Build Trolley
£350.00 / KOE0136



Momo Steering Wheel & Boss
Momo Steering Wheel / £190.00 / INT0012
Momo Steering Wheel Boss / £60.00 / INT0077
Quick Release Boss / £108.99 / INT0013
